

USER MANUAL



An all new concept projector which opens the most fashion life style to you.

Please read this manual carefully before using it.

ATTENTION

1. Please read this manual carefully before using it.
2. To ensure stable power supply, please use good supply line and outlet with grounding.
3. Please use the power supply indicated on the projector and the wire provided with the projector.
4. Please do not dismantle the projector without authorization; otherwise the supplier bears no responsibility for maintenance service.
5. Do not look into the lens while the projector is on working to prevent eyes from hurting.
6. Do not place the projector on the articles which may become obstacles for ventilation.
7. This projector has no waterproof function; you need to keep it away from water. And vessels with water should not be placed around it.
8. To avoid electric shock, please keep the projector from rain and dampness.
9. Please shut off the projector and unplug the wire if the projector will not be used for a long time.
10. When the projector is transported, please use the plastic foam and other anti-shock materials provided with the projector.
11. If the projector is found to be damaged, please do not try to repair by yourself and please contact the distributor.

** This manual is for reference only. If you have any questions, please contact the distributor.

Table of contents

1. Production Profiles

◆ Product Features	-----	15
◆ Specifications	-----	16
◆ Fittings	-----	16

2. User Guide

◆ Connection	-----	17
◆ Function Operating	-----	19
◆ Menu Operating	-----	20
◆ Remote Control	-----	22

1. Production Profiles

1.1 Product Features

- 1) All sealed design, release you from daily internal cleaning.
- 2) Using of the 20 thousand hours long life RGB-LED lamp, which makes it more colourful and abundant details.
- 3) Electronics zooming function and free image size setting.
- 4) Professional trouble shooting and protection design.
- 5) Small in size and light in weight.
- 6) Free exchange from 16:9 to 4:3.
- 7) Low noise design and dust free desing, free you from internal cleaning.
- 8) Image rolling function support upwards and downwards installing.
- 9) Power consumption lower to 24W.
- 10) Multi input interface: AV, VGA, USB, SD, HDMI, vehicle power supported.

1.2 Specifications

Model No.	Mini Projector	Image System	LCD
Input Terminal	AV、VGA、USB、SD、 HDMI	Support Resolution	1920*1080
Lamp	LED	Voltage Input	12V
Menu Language	Chinese/English...	Brightness	400lumens
Contrast	300:1	Lens	F=125
Projection Size	20-120inches	Projection Distance	1-3.8meters
Color	16770K	Power Waste	24W
Speaker	1.0W*2	Weight	0.5KG
Size	127*126*56mm	Operation Model	Manual&Remote Control
Working Temperature	-10°C-28°C	Biggest Support Memory card	16G

1.3 Fittings

Please check if the fitting is complete before you buy this projector.

Remote Control	1 piece	User Manual	1 piece
Power Adapter	1 piece	QC Card	1 piece
3 in 1 cable	1 piece		

2. User Guide

2.1 Connection

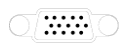
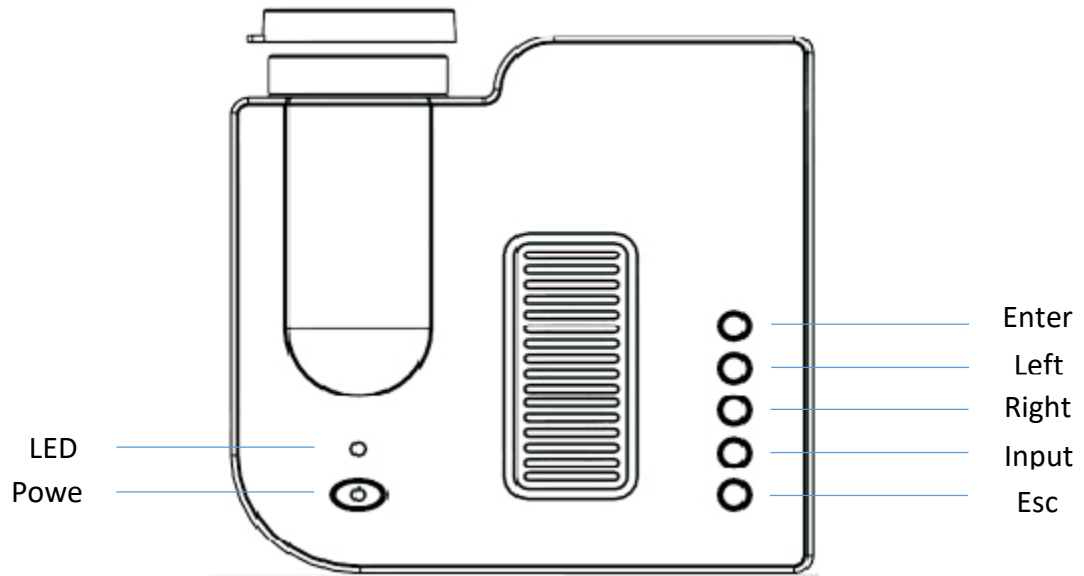

VGA



HDMI



IR

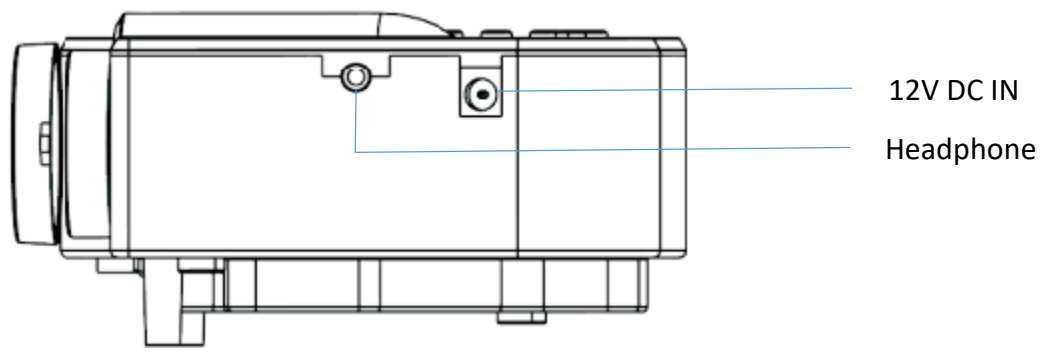
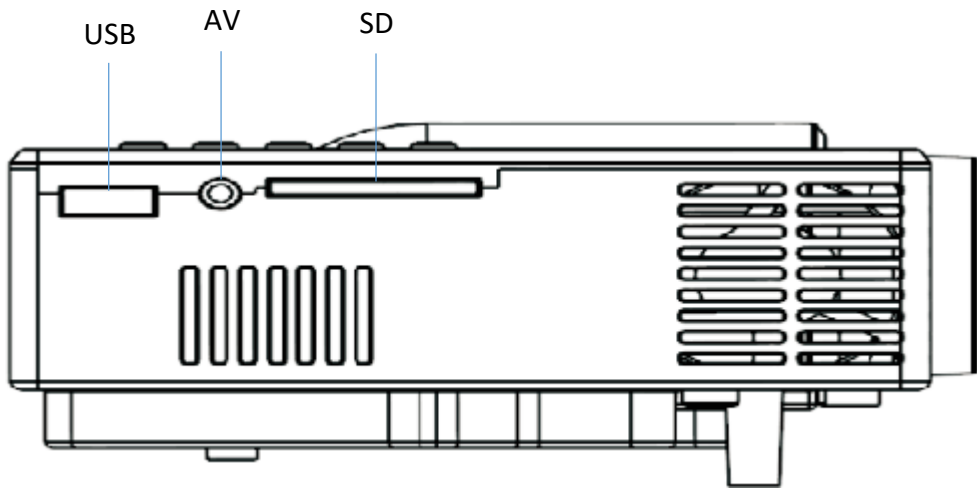

2.2 Function Operating

2.2.1 Switch-on and off

After powering through the power adapter, then projector is under standby status.

Switch-on: Press the power button or the power button on the remote control once, and then projector is powered on.

Switch-off: When you want to shut the projector, please press the power button beside the indicate light or the power button on the remote control once, and then the projector is off.

2.2.2 Image Focus

Place the projector vertical to the projection screen, and then the rotate the lens slightly, until the brilliant image presented.

Attention

Please connect the power adapter with the projector first, then plug the socket into the outlet. Finally power on the projector.

2.3 Menu Operation

A. Signal Source Selection

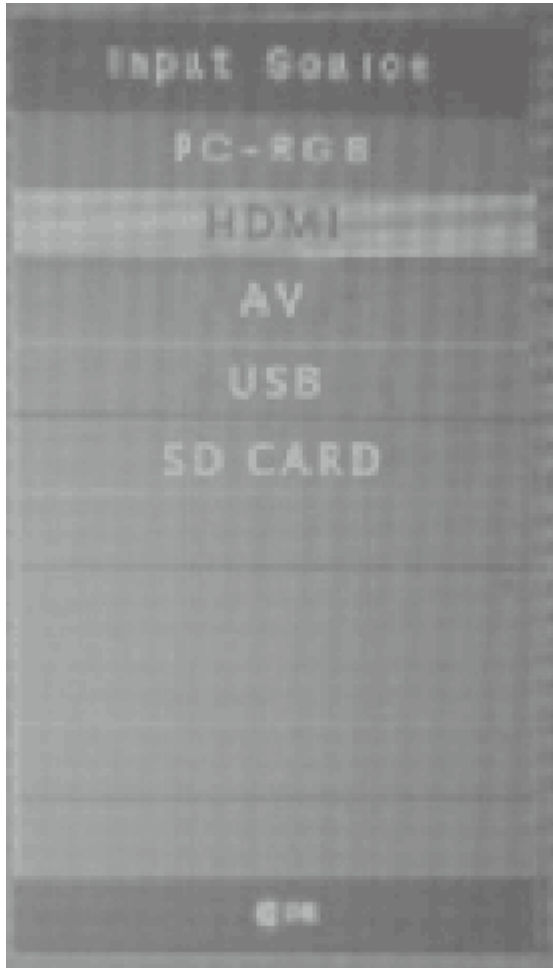

Press signal input selection button on the remote control or input button on the projector, then press up or down button to select the signal source you need, use OK or enter to confirm.

B. Sub-menu Adjustment

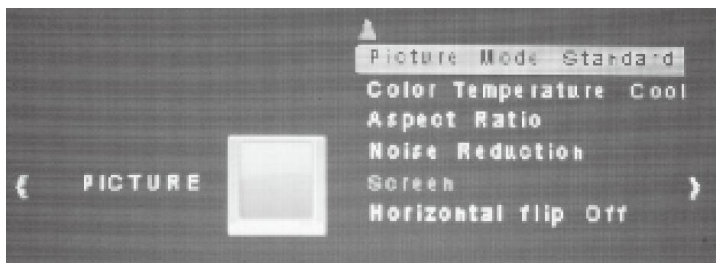

Press "menu" enter into the main menu, press "◀/▶" button to choose "picture", "sound", "clock" or "setting" menu to adjust the parameters you need.

C. USB Menu



After you have choose media signal source, the interface change to the above picture, and then you can play correspondent files through “photo”, “music”, “movie” and “text” icon by the projector accordingly.

2.4 Remote Control

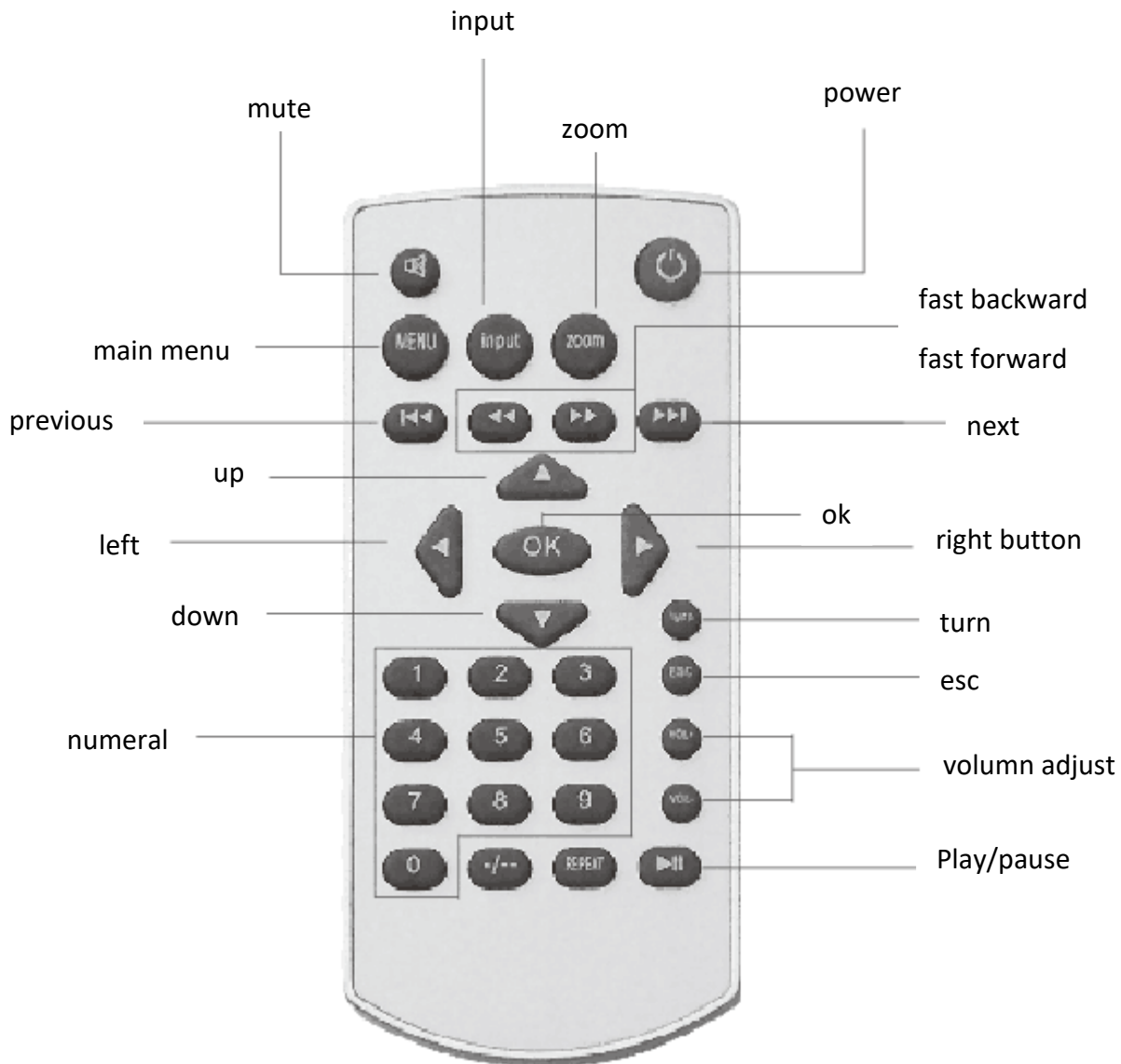

Don't use the new and old battery at the same time in remote control, otherwise power shortage and will affect remote control use. Please pick the battery out if no use for long time. When operating remote control, please make sure that the signal emission of the remote control aims the infrared receiving interface of projector.